

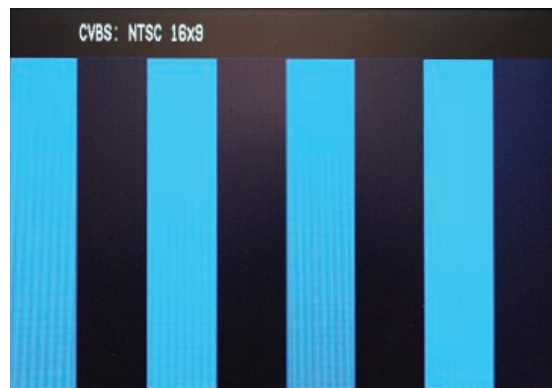

OSD

Use SELECT to enable the On Screen Display for input and function status



Blue Only

SELECT to adjust SMPTE or split field color bars.

1. Allow monitor to warm up for 5-10 minutes minimum.
2. Display SMPTE color bars on monitor. Turn on off Color with control.
3. Find the PLUGE (superblack, black, and gray bars) at the lower right of the pattern.

Adjust BRIGHTNESS until there is no difference visible between the super-black and black bars, but is still visible.

4. Adjust CONTRAST control to achieve a balanced gray scale across top bars.

5. Turn up CHROMA (color level) control until the two outermost bars (white and blue appear to match in brightness).

6. NTSC Only -Adjust COLOR PHASE (tint or hue) control until the third bar from the left (cyan) and the third bar from the right (magenta) appear to match in brightness.

10 Warranty

Marshall Electronics warrants to the first consumer, that this V-R102DP-SD Dual 10.4-inch LCD rack mounted monitor set will, under normal use, be free from defects in workmanship and materials, when received in its original container, for a period of one year from the purchase date.

This warranty is extended to the purchasing end user only and proof of purchase is necessary to honor the warranty. If there is no proof of purchase provided with a warranty claim, Marshall Electronics reserves the right not to honor the warranty set forth above. Therefore, labor and parts may be charged to you.

This warranty does not apply to product exterior and cosmetics. Misuse, abnormal service or handling, improper alterations or modifications in design or construction, voids this warranty. No sales personnel of the seller, nor any other person is authorized to make any warranties other than those described above, or to extend the duration of any warranties on behalf of Marshall Electronics, beyond the time period described above.

An extra note about LCD displays: It is considered normal for a minimal amount of pixels, not to exceed three, to fail on the periphery of the display active viewing area. Marshall Electronics has the option to reserve service for display pixel failure if deemed unobtrusive to effective use of the monitor by our technicians.

Due to constant effort to improve products and product features, specifications may change without notice.

Marshall Electronics

1910 East Maple Ave.
 El Segundo, CA 90245
 Tel.: 800-800-6608 • 310-333-0606
 Fax: 310-333-0688
 www.LCDRacks.com
 Email: sales@lcdracks.com

V-R102DP-SD Users Guide

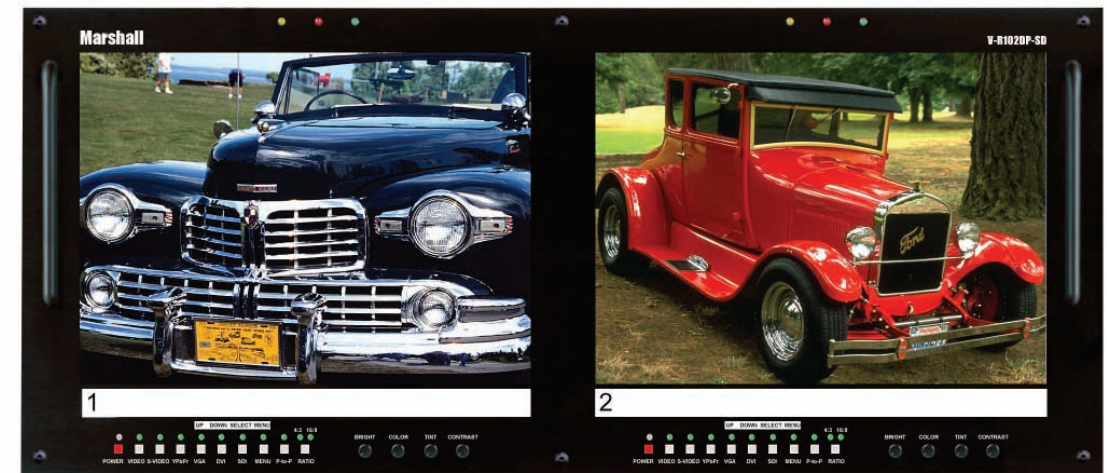

Product Overview	1
Features	2
Video - Screen Formats and Frame Rates	3
Electrical Specifications	4
Mechanical Specifications	5
Operational Setup	6
Connectors	7
Switch Settings, Adjustments and Indicators	8
Menu Functions	9
Warranty	10

1 Product Overview

The **V-R102DP-SD** features our Completely Digital TFT-Megapixel™ high definition TFT/LCD system with 1.44 million pixels. Analog signals are digitized using an advanced 10 bit process with 4x over sampling and adaptive 5 line comb filter plus exacting color space conversion. Video is scaled to fit on screen in the highest resolution using a state of the art LSI that incorporates 6x6 pixel adaptive motion interpolation with precision Gamma correction. Additional features include Pixel-to-Pixel™ native resolution scaling, setup memory, Underscan, H/V Delay, adjustable color temperature, and Blue Gun.

2 Features

- **TFT-MegaPixel™ totally digital end to end signal processing**
- **Multiple format acceptance for virtually any analog or digital video signal**
- **Display PC Signals to XGA 1024x768**
- **ColorMatch Conversion™ with SMPTE/EBU color space emulation of CRT**
- **Color temperature preset for D65**
- **HyperProcess™ motion interpolation of interlace images**
- **On screen display of input status, formats, and menu functions**
- **Pixel to Pixel™ native resolution display**
- **Ready to mount – all brackets are factory installed**
- **Lightweight – 75% lighter than CRT models**
- **Settings memory restores active state with power off/on cycle**
- **Underscan plus H & V delay**
- **Blue only (Blue Gun) for adjustment to SMPTE color bars**
- **Includes V-PS12-5V-1 Universal power supply (U.L. class 2)**
- **Three LEDs (Red, Green, Amber) produce 7 different tally indications on each screen**
- **Dry erase label for each screen**

3 Video - Screen Formats and Frame Rates All signal types and frame rates are automatically detected

- 525 –60i / 625 - 50i (Interlaced NTSC/PAL)
- 480P (Progressive)
- 576P (Progressive)
- 720P-50P, 59.94P, 60P, 25P, 29.97P, 30P, 50P, 59.94P, 60P (Progressive)
- 1035i - 59.94i, 60i (Interlaced)
- 1080i x 1920 – 50i, 59.94i, 60i, 23.973P, 24P, 25P, 29.97P, 30P, 24psf, 23.97psf

4 Electrical Specifications

Screen Aspect	4:3/16:9 switchable
Display (Viewing Area)	8.4 Inch diagonal (170.4mm w x 127.8mm h)
Viewing Angles	130° H x 120° V
Resolution (RGB Dots)	800HxRGBx600V (1.44 million pixels)
Color Depth	262,000 Colors (6-Bit)
Dot Pitch	.213mm square pixel
Contrast Ratio	350:1
Pixel Response	10ms rise/25ms fall
Brightness (in cd/m²)	500 cd/m ²
Backlight	Field Replaceable CCFL (50,000 hour half life)
LCD Screen Treatments	Anti Reflection, Anti Glare, Hardcoat
Estimated MTBF	5 years of 24/7/365 operation
System	NTSC/PAL with auto recognition
Inputs	SDI (SMPTE259M) (ITR-U601) per screen (BNC) YPrPb Component (3 BNC) Composite Video PAL/NTSC auto detect (BNC) S-Video (Y/C) (4 Pin Mini Din female) XGA 15Pin HD-15 Female DVI 27 (Pin DVI-I Female) Tally (HD-15 Female)
Active Outputs	SDI (SMPTE259M) (ITU-RBT601) per screen (BNC) YPrPb Component (3 BNC) Composite Video PAL/NTSC auto detect
Color temperature	D65 and User Adjustment
Color Gamut	SMPTE-C/EBU 80% CIE
Luma Linearity	Typical +/- 3% with 5 IRE increments (0 to 10 IRE)
Power Required	10.8 to 13.2 VDC
Power Consumption	Approx. 40 watt nominal
Operating temperature	32° F to 120° F (0° C to 50° C)
Storage temperature	-4 F to 120° F (-20° C to 50° C)
Compliance	€, FCC-Class A, ANSI-63.4 (Certificates on file)
RoHS WEE / Environmental	 Do not dispose. Return to Manufacturer or Authorized Recycle Facility

9 Menu Functions

1. Power On/Off Button

Illuminates Red when system power is present. Illuminates Green when monitor is ON.

2. Source Selection Buttons

Video - Composite NTSC or PAL. Composite video must comply to SMPTE-RS170M.

Images without color burst (Subcarrier) component may not display.

S-Video - Y/C (Luminance + Chrominance) NTSC or PAL.

YPrPb - Analog Component color difference signals for Standard Definition (YCrCb) or High Definition (YPrPb).

VGA - Analog PC.

DVI - Digital Computer or Video Signals. Includes HDCP for use with HDMI originated signals.

SDI - Digital Input for Standard Definition (SDI-270Mbs).

3. Pixel to Pixel Function

As the native LCD displays of the V-R102DP-SD are 800 pixels wide by 600 dots (RGB pixels) high, it is necessary to change the size of the image to fill the whole screen. Pixel to Pixel mode bypasses the enlargement/shrink of this scaling function and displays the native incoming format.

For 525-NTSC/480P based images, pixel to pixel will appear as a 480x640 (4:3 aspect) or 480x720 (16:9 aspect).

For 625-PAL/576P based images, pixel to pixel will appear as a 576x640(4:3 aspect) or 576x720 (16:9 aspect).

For 1080 line HD based images, pixel to pixel will appear as cropped 800x600 (4:3 aspect) starting from the center of the image. 240 lines top, 240 lines bottom, 560 pixels left and 560 pixels right will be cropped.

For 720 line HD based images, pixel to pixel will appear as cropped 800x600 (4:3 aspect) with 60 lines from the top and 60 lines from the bottom cropped. Horizontally, 240 pixels will be cropped from each edge.

3. Menu Enable and navigation

Access menu functions by selecting the **MENU** button. Use **UP / DOWN** to navigate and **SELECT** to enable or disable the function

Note: Source selection is disabled when in menu mode.

Color Temperature

D-65 (6500K) - Standard setting recommended by SMPTE and EBU.

Simulates normal daylight conditions.

USER - When activated manual adjustment is performed by selecting

Adj. Color Gain or **Adj. Color Bias**

Adjust Gain R:032

Adjust Bias R:000

When in adjust mode use **UP/DOWN** to change values. Use **SELECT** to cycle RED, GREEN, and BLUE mode. Exit to the main menu by pressing **MENU**.

Left Line= Increase of Gain
Center Line = D65 (Default)
Right Line = Decrease of Gain

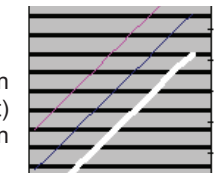

Right Line= Increase of Bias
Center Line = D65 (Default)
Left Line = Decrease of Bias

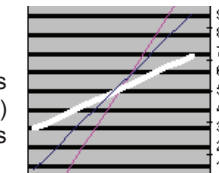

Level Set-up

SELECT between 7.5 IRE for NTSC signals and 0 IRE for NTSC Japan and PAL signals. 7.5 mode will enable a digital black offset of the onscreen images for improved Blacks.

Color Bar

Use to **SELECT** internal test signal of full field color bars that is available for confirmation of LCD operation. This function will disable input selection until cycled off.

H/V Delay

Use to **SELECT** display of horizontal and vertical blanking areas. Not available for all signal types.

Under Scan

Use **SELECT** to reduce the display area with expansion beyond active video. Note that the V-R102DP-SD is factory adjusted to display 100% of active video in standard display mode. This function is normally used with analog Standard definition signals. SDI signals will display all video with ancillary data appearing to the right of the image.

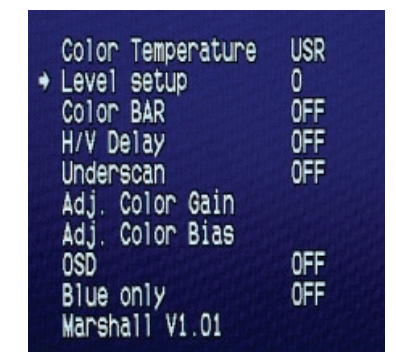
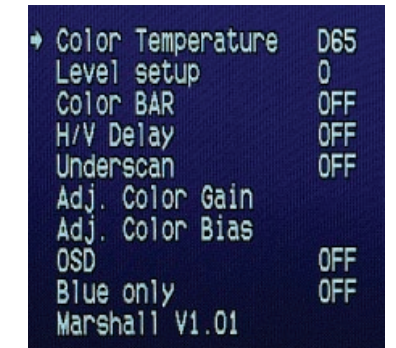

8 Switch Settings, Adjustments and Indicators

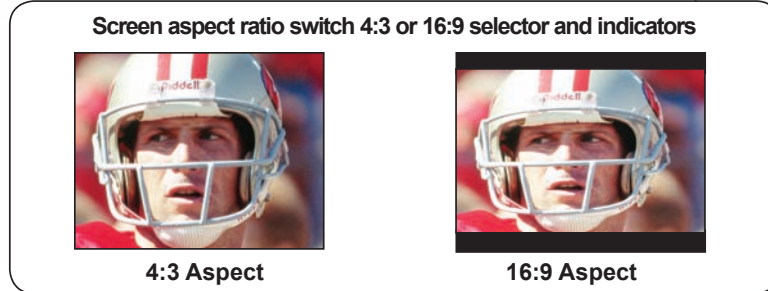
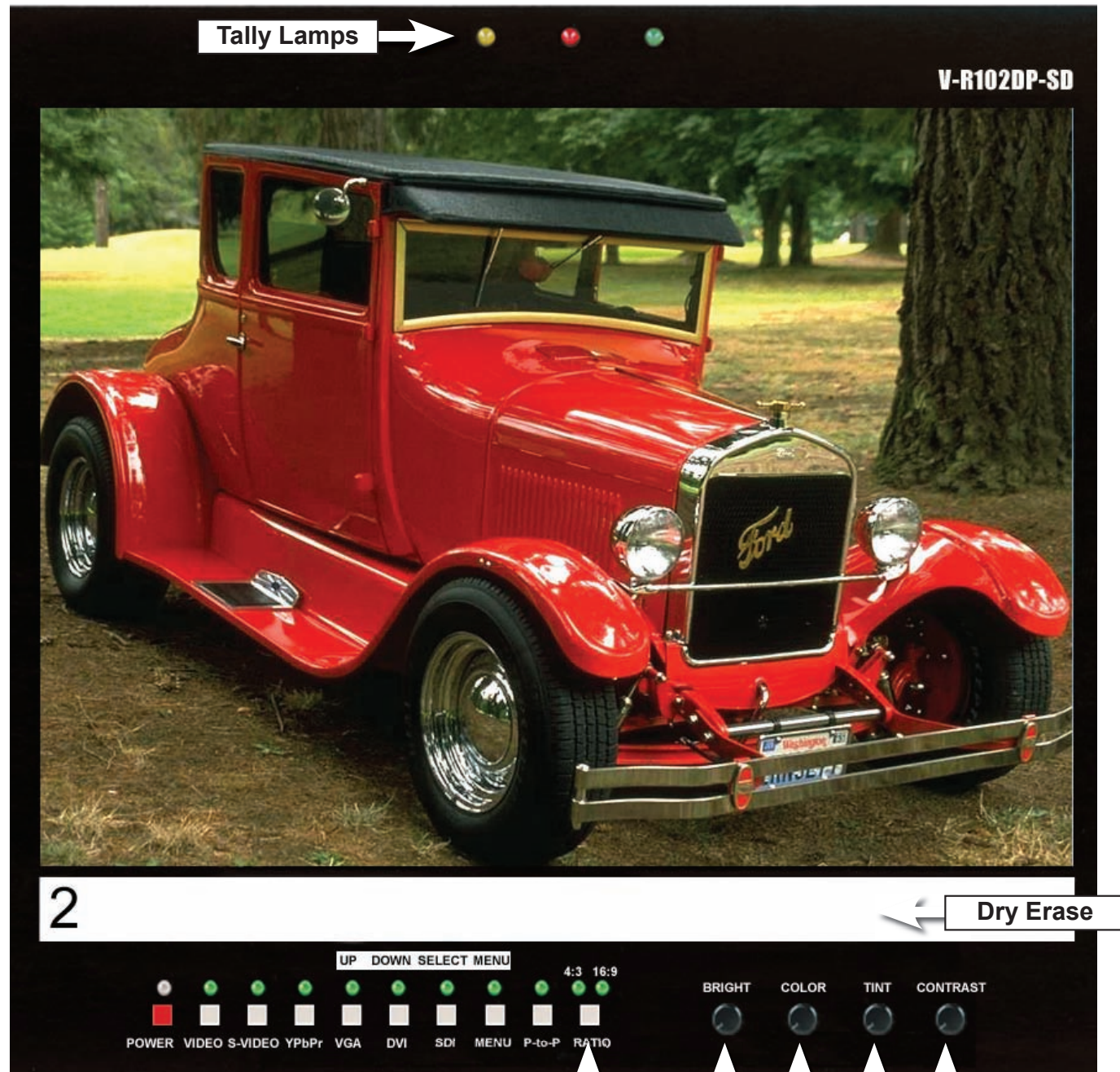

Image Adjustment Controls
 Note: Tint only functions when NTSC Video or S-Video are selected

5 Mechanical Specifications

Dimensions	19.12" w x 8.67" h x 1.5" d (485.7mm x 220.22mm x 38.1mm)
V-R102DP-SD Weight	5.5 lbs (2.4 kg)
V-PS12-5V-1 Power Supply Weight	1 lbs (0.45kg)

6 Operational Setup

1. Unpack the V-R102DP-SD and accompanying V-PS12-5V-1 power supply. Physically inspect for any damage that may have occurred during shipping. Should there be any damage, immediately contact Marshall Electronics at 800-800-6608. If you are not located within the continental United States call +1 310-333-0606.
2. After inspection, install in your desired location of a standard EIA 19-inch equipment rack. Adequate ventilation is required when installed to prevent possible damage to the V-R102DP-SD internal components.
3. Connect required cables for signal input and output. Please note that power must be applied to the V-R102DP-SD for all outputs to be activated. All BNC connectors should be rated for 75Ω.
4. Plug the V-PS12-5V-1 power supply into the A.C. source
5. Attach twist lock power connection from V-PS12-5V-1 power supply to the back of the unit.
6. Turn on each of the V-R102DP-SD screens by depressing the power switch located on the front of the unit for each screen.

7 Connectors

- * SDI Inputs comply to SMPTE-259M, SDI-270Mbs
- * Component Inputs comply to SMPTE274M, 294M,295M,296M
- * Composite Video Inputs comply to SMPTE-170M
- * Tally lamps active when connected to ground

Tally IN DB-15 Female	
Pin1-M2Yel	Pin9-
Pin2-M2Red	Pin10-
Pin3-M2Grn	Pin11-M1Yel
Pin4-	Pin12-M2Red
Pin5-Gnd	Pin13-M3Grn
Pin6-	Pin14-
Pin7-	Pin15-Gnd

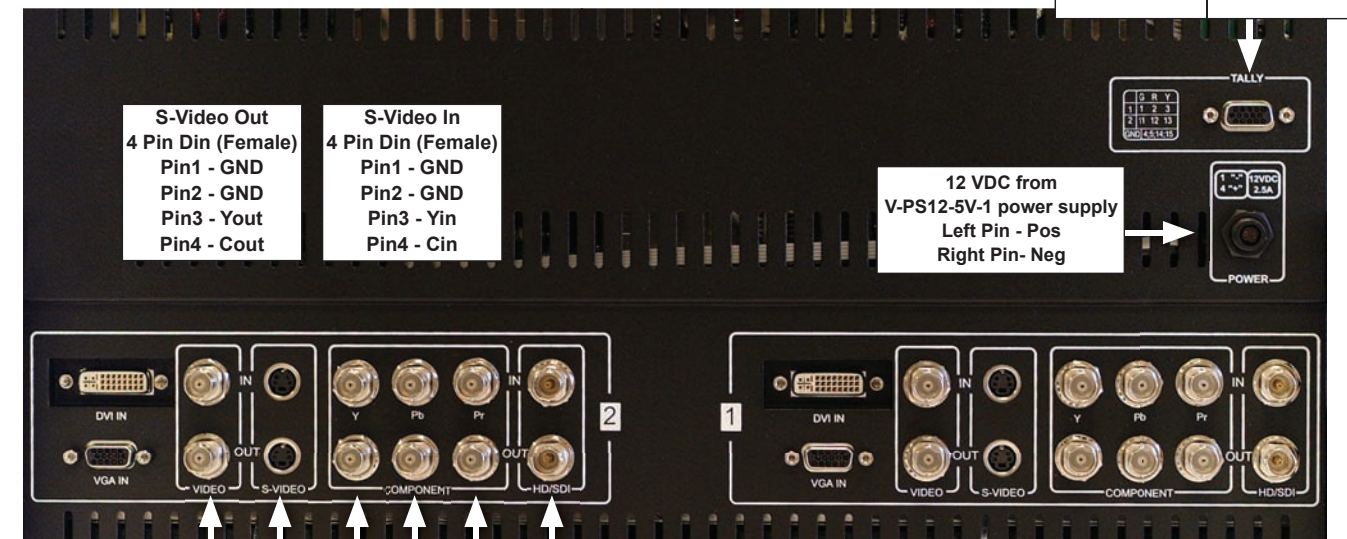

VGA/XGA Connector			
PIN#	SIGNAL	PIN#	SIGNAL
1	RED	9	NC
2	GREEN	10	NC
3	BLUE	11	NC
4	NC	12	NC
5	GND	13	HSYNC
6	RED SHIELD	14	VS YNC
7	GREEN SHIELD	15	NC
8	BLUE SHIELD		

DVI Connector			
Pin#	Signal	Pin#	Signal
1	T.M.D.S DATA 2-	16	HOT PLUG DETECT
2	T.M.D.S DATA 2+	17	T.M.D.S DATA 0-
3	T.M.D.S DATA 2/4	18	T.M.D.S DATA 0+
4	SHIELD	19	T.M.D.S DATA 0/5
5	T.M.D.S DATA 4-	20	T.M.D.S DATA 5-
6	T.M.D.S DATA 4+	21	T.M.D.S DATA 5+
7	DDC CLOCK	22	T.M.D.S CLOCK
8	SHIELD		
9	ANALOG VERT. SYNC	23	T.M.D.S CLOCK+
10	T.M.D.S DATA 1-	24	T.M.D.S CLOCK-
11	T.M.D.S DATA 1+		
12	T.M.D.S DATA 1/3	C1	ANALOG RED
13	SHIELD	C2	ANALOG GREEN
14	T.M.D.S DATA 3-	C3	ANALOG BLUE
15	T.M.D.S DATA 3+	C4	ANALOG HORZ SYNC
	+5V POWER	C5	ANALOG GROUND
	GND		

Table 1 / Computer Signals Displayed via DVI and VGA connector

Input Signal Type and aspect	DVI-D		VGA	
	4x3	16x9	4x3	16x9
640 x 480 60Hz	Y	Y	Y	Y
640 x 480 75Hz	Y	Y	Y	Y
640 x 480 85Hz	Y	Y	Y	Y
800 x 600 60Hz	Y	Y	Y	Y
800 x 600 75Hz	Y	Y	Y	Y
800 x 600 85Hz	Y	Y	Y	Y
1024 x 768 60Hz	Y	Y	Y	Y
1024 x 768 75Hz	Y	Y	Y	Y
1024 x 768 85Hz	Y	Y	Y	Y

**Table 2 / Video Signals Displayed via DVI and YPrPb connections
(x=not available) (HDMI requires adapter to DVI)**

Input Signal Type and aspect	Y Pr Pb		DVI	
	4x3	16x9	4x3	16x9
720 x 486 60i	Y	Y	x	x
720 x 576 50i	Y	Y	x	x
1280 x 720 60P	Y	Y	Y	Y
1280 x 720 50P	Y	Y	Y	Y
1280 x 720 30P	Y	Y	x	x
1280 x720 29.97P	Y	Y	x	x
1280 x720 25P	Y	Y	x	x
1280 x 720 24P	Y	Y	x	x
1280 x 720 23.98P	Y	Y	x	x
1920 x 1080 60i	Y	Y	Y	Y
1920x1080 59.94i	Y	Y	Y	Y
1920 x 1080 50i	Y	Y	Y	Y
1920 x 1080 30P	Y	Y	Y	Y
1920x1080 29.97P	Y	Y	Y	Y
1920 x 1080 25P	Y	Y	Y	Y
1920 x 1080 24P	Y	Y	Y	Y
1920 x 1080 24Psf	Y	Y	Y	Y

Table 3 / Video Signals Displayed via SDI

Input Signal Type and aspect	SDI	
	4:3	16:9
NTSC (720x486i 60Hz)	Y	Y
PAL (720 x 576i 50Hz)	Y	Y